

e94 LED WORK LAMPS

FROM GROTE



ALUMINUM
CONSTRUCTION

12/24V

DUAL
VOLTAGE



FLOOD
BEAM PATTERN

OEM

OEM
SPEC

WITH MULTIPLE OUTPUT LEVELS, AND BEAM PATTERNS, GROTE'S e94 LED WORK LAMPS DELIVER A POWERFUL AND VERSATILE EQUIPMENT LIGHTING SOLUTION.



OPTICAL CHARACTERISTICS

Color Temperature (CCT)	5700K
Color Rendering Index (CRI)	70

ELECTRICAL CHARACTERISTICS

Operating Voltage Range	9 - 32 V
Operating Temperature Range	-40° C to +50° C
Reverse Polarity Protection	✓
Overheat Protection	✓
ESD, Overvoltage and Transient Protection	✓

MECHANICAL CHARACTERISTICS

Materials	Lens: UV-resistant Polycarbonate Housing: Aluminum Powder-Coated
IP Code	IP69
Maximum Storage Temperature	-55° C to +110° C
Impact and shock resistance	50 G
Vibration Resistance	5 G (5 - 500 Hz)

APPROVALS AND CERTIFICATES

ISO 7637-2	✓
ISO 10605	✓
ISO 11452	Section 2, 4 and 5
ISO 20653	✓

FEATURES & BENEFITS

- Thanks to a variable voltage range of 9 to 32 volts, e94 LED Work Lamps are highly adaptable for different environments
- Meet stringent EMC requirements in accordance with CISPR 25 Class 4
- Constant luminance over the whole operating temperature range
- State-of-the-art TIR-only lens design maximizes optical efficiency
- Rated IP69K, making it pressure-washer safe
- Circuitry protected against automotive transients, DC over- and undervoltage, and ESD
- Tested in accordance with ISO 14982 and EN 13309 for agricultural, forestry, and construction-site machinery
- Unique thermal design improves durability for a lamp that lasts longer

PRODUCT NUMBER	BEAM PATTERN	LUMENS	VOLTAGE	AMPERAGE	MOUNTING TYPE
64L61	FAR FLOOD	1200	9-32V	0.78 A (14 V); 0.45 A (28 V)	PENDANT
64L71	NEAR FLOOD	1200	9-32V	0.78 A (14 V); 0.45 A (28 V)	PENDANT
64T61	FAR FLOOD	2000	9-32V	1.86 A (14 V); 0.98 A (28 V)	PENDANT
64T71	NEAR FLOOD	2000	9-32V	1.86 A (14 V); 0.98 A (28 V)	PENDANT



EZ-FIND
SCAN FOR TECH SPECS,
RELATED PRODUCTS
AND MORE

FOR MORE INFORMATION
VISIT OUR WEBSITE.
GROTE.COM

Grote

e94 LED WORK LAMPS FROM GROTE



ALUMINUM
CONSTRUCTION

12/24V

DUAL
VOLTAGE



FLOOD
BEAM PATTERN

OEM

OEM
SPEC

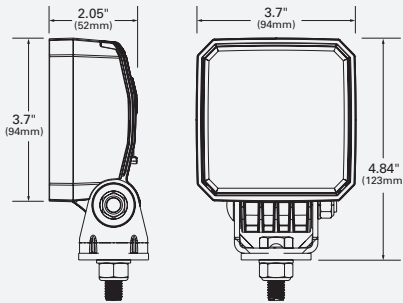

FAR RANGE - (64T31 & 64T61)

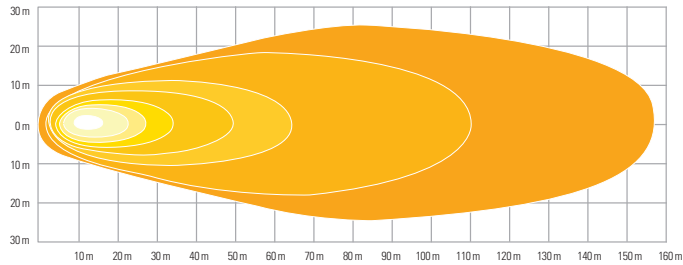

FAR RANGE - (64L31 & 64L61)

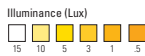
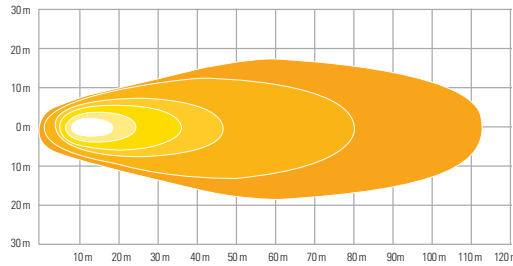

CLOSE RANGE - (64T41 & 64T71)

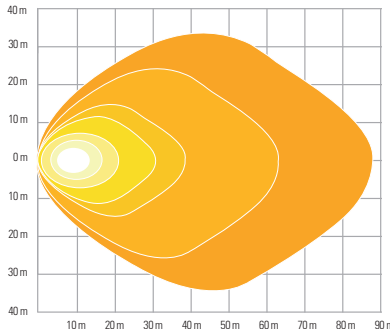

CLOSE RANGE - (64L41 & 64L71)

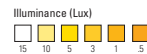
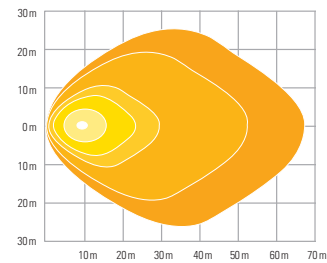

EZ-FIND
SCAN FOR TECH SPECS,
RELATED PRODUCTS
AND MORE

FOR MORE INFORMATION
VISIT OUR WEBSITE.
GROTE.COM

